

## P/N: 63907-0804

### Copyright

© 2020, FLIR Systems, Inc.

All rights reserved worldwide. Names and marks appearing herein are either registered trademarks or trademarks of FLIR Systems and/or its subsidiaries. All other trademarks, trade names or company names referenced herein are used for identification only and are the property of their respective owners.

### Document identity

Publ. No.: 63907-0804

Commit: 68817

Language:

Modified: 2020-07-14

Formatted: 2020-07-14

### Website

<http://www.flir.com>

### Customer support

<http://support.flir.com>

### Disclaimer

Specifications subject to change without further notice. Camera models and accessories subject to regional market considerations. License procedures may apply. Products described herein may be subject to US Export Regulations. Please refer to [exportquestions@flir.com](mailto:exportquestions@flir.com) with any questions.



### General description

The FLIR Ex series cameras are point-and-shoot infrared cameras that give you access to the infrared world. A FLIR Ex series camera is an affordable replacement for an infrared thermometer, providing a thermal image with temperature information in every pixel. The new MSX and visual formats make the cameras incomparably easy to use.

The FLIR Ex series cameras are user-friendly, compact, and rugged, for use in harsh environments. The wide field of view makes them the perfect choice for building applications.

#### Benefits:

- Easy to use: The FLIR Ex series cameras are fully automatic and focus-free with an intuitive interface for simple measurements in thermal, visual, or MSX mode.
- Compact and rugged: The FLIR Ex series cameras' low weight of 0.575 kg and the accessory belt pouch make them easy to bring along at all times. Their rugged design can withstand a 2 m drop test, and ensures reliability, even in harsh environments.
- Ground breaking affordability: The FLIR Ex series cameras are the most affordable infrared cameras on the market.

### Imaging and optical data

IR resolution	240 × 180 pixels
Thermal sensitivity/NETD	< 0.06°C (0.11°F) / < 60 mK
Field of view (FOV)	45° × 34°
Minimum focus distance	0.5 m (1.6 ft.)
Spatial resolution (IFOV)	3.4 mrad
F-number	1.5
Image frequency	9 Hz
Focus	Focus free

### Detector data

Detector type	Focal plane array (FPA), uncooled microbolometer
Spectral range	7.5–13 μm

### Image presentation

Display	3.0 in. 320 × 240 color LCD
Image adjustment	Automatic/Manual

P/N: 63907-0804

© 2020, FLIR Systems, Inc.

#63907-0804; r. 68817;

<b>Image presentation modes</b>	
Image modes	Thermal MSX, Thermal, Picture-in-Picture, Thermal blending, Digital camera.
Multi Spectral Dynamic Imaging (MSX)	IR image with enhanced detail presentation
Picture in Picture	IR area on visual image
<b>Measurement</b>	
Camera temperature range	<ul style="list-style-type: none"> <li>-20 to 250°C (-4 to 482°F)</li> <li>10 to 550°C (50 to 1022°F)</li> </ul>
Object temperature range and accuracy (for ambient temp. 10 to 35°C (50 to 95°F) and object temp. above 0°C (32°F))	<ul style="list-style-type: none"> <li>Range -20 to 250°C (-4 to 482°F):               <ul style="list-style-type: none"> <li>0 to 100°C (32 to 212°F): ±2°C (±3.6°F)</li> <li>100 to 250°C (212 to 482°F): ±2%</li> </ul> </li> <li>Range 10 to 550°C (50 to 1022°F):               <ul style="list-style-type: none"> <li>10 to 100°C (50 to 212°F): ±3°C (±5.4°F)</li> <li>100 to 550°C (212 to 1022°F): ±3%</li> </ul> </li> </ul>
<b>Measurement analysis</b>	
Spotmeter	Center spot
Area	Box with max./min.
Isotherm	Above alarm, Below alarm
Emissivity correction	Variable from 0.1 to 1.0
Emissivity table	Emissivity table of predefined materials
Reflected apparent temperature correction	Automatic, based on input of reflected temperature
<b>Set-up</b>	
Color palettes	Black and white, iron and rainbow
Set-up commands	Local adaptation of units, language, date and time formats
<b>Storage of images</b>	
File formats	Standard JPEG, 14-bit measurement data included
<b>Digital camera</b>	
Digital camera, resolution	640 × 480
Digital camera, FOV	55° × 43°
<b>Data communication interfaces</b>	
Interfaces	USB Micro: Data transfer to and from PC and Mac device
Wi-Fi	Peer-to-peer (ad hoc) or infrastructure (network)
<b>Radio</b>	
Wi-Fi	<ul style="list-style-type: none"> <li>Standard: 802.11 b/g/n</li> <li>Frequency range:               <ul style="list-style-type: none"> <li>2400–2480 MHz</li> <li>5150–5260 MHz</li> </ul> </li> <li>Max. output power: 15 dBm</li> </ul>
<b>Power system</b>	
Battery type	Rechargeable Li ion battery
Battery voltage	3.6 V



# FLIR E6xt (incl. Wi-Fi)

P/N: 63907-0804

© 2020, FLIR Systems, Inc.

#63907-0804; r. 68817;

Power system	
Battery operating time	Approx. 4 hours at +25°C (+77°F) ambient temperature and typical use
Charging system	Battery is charged inside the camera or in specific charger.
Charging time	2.5 hours to 90% capacity in camera. 2 hours in charger.
Power management	Automatic shut-down
AC operation	AC adapter, 90–260 VAC input, 5 VDC output to camera

Environmental data	
Operating temperature range	–15°C to +50°C (+5°F to +122°F)
Storage temperature range	–40°C to +70°C (–40°F to +158°F)
Humidity (operating and storage)	IEC 60068-2-30/24 h 95% relative humidity
EMC	<ul style="list-style-type: none"> <li>EN 61000-6-2 (Immunity)</li> <li>EN 61000-6-3 (Emission)</li> <li>FCC 47 CFR Part 15 Class B (Emission)</li> <li>RCM</li> </ul>
Radio spectrum	<ul style="list-style-type: none"> <li>ETSI EN 300 328</li> <li>ETSI EN 301 893</li> <li>FCC 47 CFR Part 15 C, E</li> <li>RSS-247 Issue 2</li> </ul>
Hazardous substances	<ul style="list-style-type: none"> <li>WEEE 2012/19/EU</li> <li>RoHs 2011/65/EU</li> </ul>
Encapsulation	IP 54 (IEC 60529)
Shock	25 g (IEC 60068-2-27)
Vibration	2 g (IEC 60068-2-6)
Drop	2 m (6.6 ft.)
Safety	Camera: IEC/EN60950-1 Power supply: UL, CSA, CE, PSE, CCC, and SAA

Physical data	
Camera weight, incl. battery	0.575 kg (1.27 lb.)
Camera size (L × W × H)	244 × 95 × 140 mm (9.6 × 3.7 × 5.5 in.)
Color	Black and gray

Shipping information	
Packaging, type	Cardboard box
List of contents	<ul style="list-style-type: none"> <li>Infrared camera</li> <li>Hard transport case</li> <li>Battery (inside camera)</li> <li>USB cable</li> <li>Power supply/charger with EU, UK, US and Australian plugs</li> <li>Printed documentation</li> </ul>
Packaging, weight	2.9 kg (6.4 lb.)
Packaging, size	385 × 165 × 315 mm (15.2 × 6.5 × 12.4 in.)
EAN-13	4743254004016
UPC-12	845188018795
Country of origin	Estonia



## FLIR E6xt (incl. Wi-Fi)

---

**P/N: 63907-0804**

© 2020, FLIR Systems, Inc.

#63907-0804; r. 68817;

### **Supplies & accessories:**

- T198528; Hard transport case FLIR Ex series
- T198531; Battery charger incl power supply
- T198532; Car charger
- T198534; Power supply USB-micro
- T198529; Pouch FLIR Ex and ix series
- T198533; USB cable Std A <-> Micro B
- T199362ACC; Battery Li-ion 3.6 V, 2.6 Ah, 9.4 Wh
- T911689ACC; Pouch for FLIR E-series
- T911093; Tool belt
- T300083; FLIR Thermal Studio Pro, Perpetual license
- T300341; FLIR Thermal Studio Standard, 1 Year Subscription
- T300258; FLIR Thermal Studio Standard, Perpetual license
- T198583; FLIR Tools+ (download card incl. license key)
- T199233; FLIR Atlas SDK for .NET
- T199234; FLIR Atlas SDK for MATLAB
- INST-EW-0125; Extended Warranty 1 Year for A5, A15, E6, E8
- INST-EWGM-0120; Premium Service Package for A5, A15, E6, E8
- INST-GM-0120; General Maintenance Package for A5, A15, E6, E8

Camera with built-in IR lens f=6,5 mm (45°)

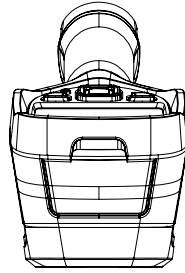
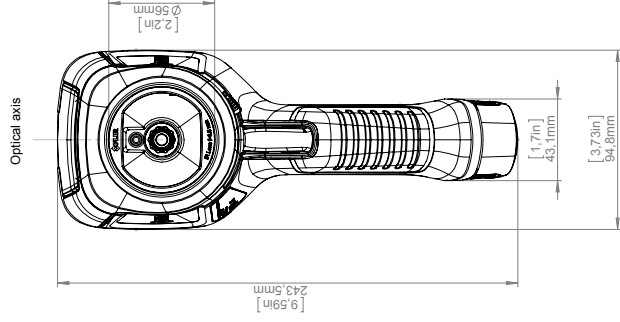
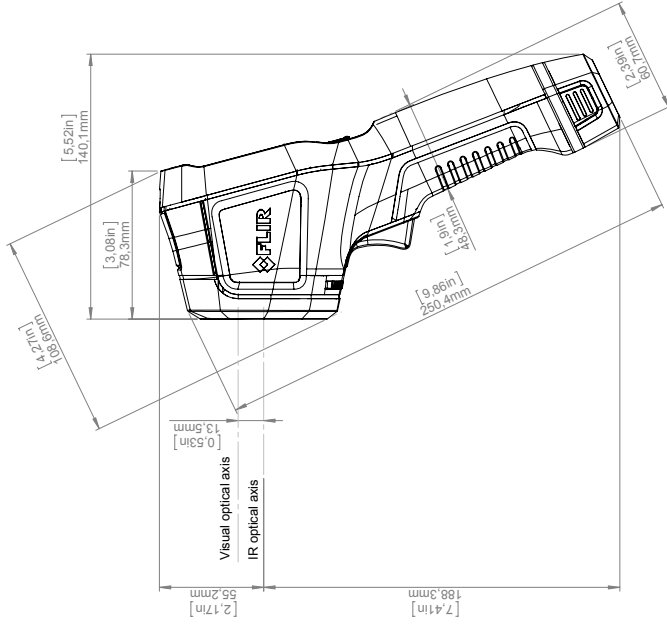
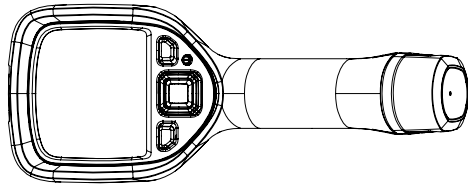
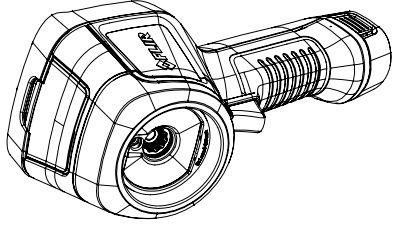
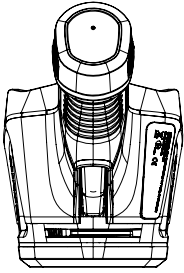

# Charger and Power pack

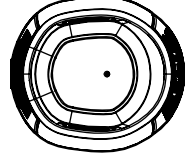
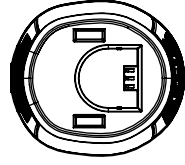
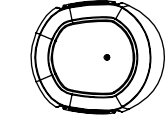
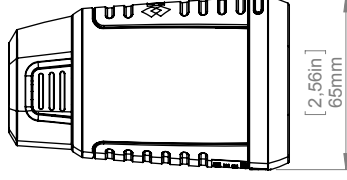
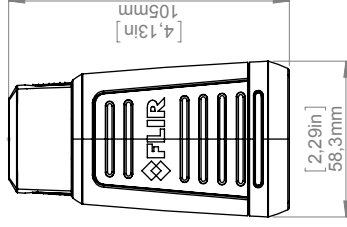
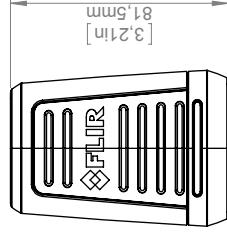
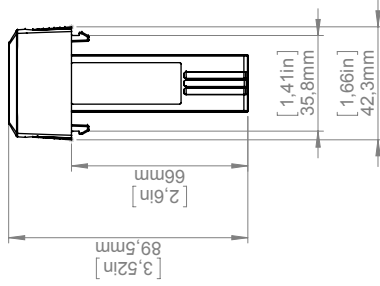
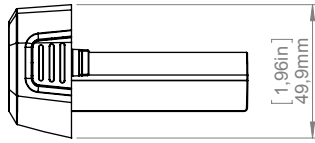
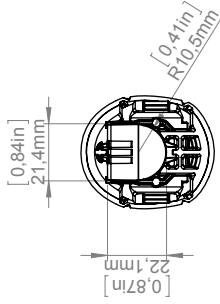
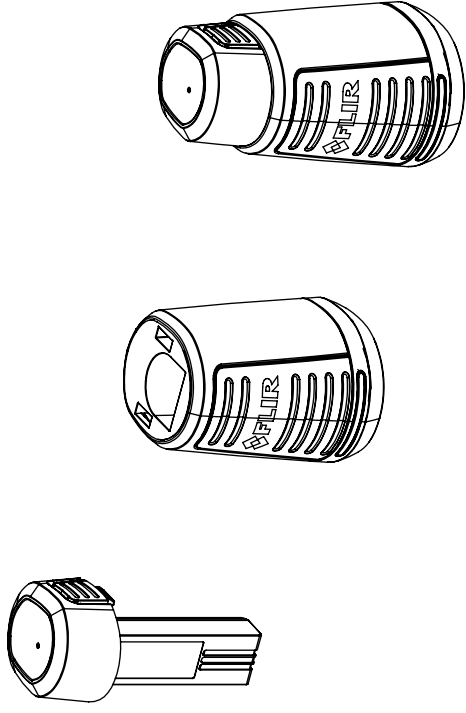

		Drawing No. <b>T127831</b> Size <b>A</b>
Modified <b>2013-03-25</b> Denomination	Check <b>CAHA</b>	Drawn by <b>R&amp;D Thermography</b>
Size <b>A3</b> Scale <b>1:2</b>		Sheet <b>2(2)</b> Size <b>A</b>
<b>Basic dimensions FLIR Ex</b>		

© 2012, FLIR Systems, Inc. All rights reserved worldwide. No part of this drawing may be reproduced, stored in a retrieval system, or transmitted in any form, or by any means, electronic, mechanical, photocopying, recording, or otherwise, without written permission from FLIR Systems, Inc. Specifications subject to change without further notice. Dimensional data is based on nominal values. Products may be subject to regional market considerations. License procedures may apply. Product may be subject to US Export Regulations. Please refer to exportquestions@flir.com with any questions. Division contrary to US law is prohibited.



January 22, 2018 Täby, Sweden

AQ320224

**CE Declaration of Conformity – EU Declaration of Conformity**

Product: FLIR EX -series

Name and address of the manufacturer:

FLIR Systems AB  
PO Box 7376  
SE-187 15 Täby, Sweden

This declaration of conformity is issued under the sole responsibility of the manufacturer.  
The object of the declaration: FLIR EX -series (Product Model Name FLIR-E6390).  
The object of the declaration described above is in conformity with the relevant Union harmonisation legislation:

**Directives:**

Directive	2012/19/EU	Waste electrical and electric equipment
Directive:	2011/65/EU	RoHS
Directive	2014/53/EU	Radio Equipment Directive (RED)
Directive	1999/519/EC	Limitation of exposure to electromagnetic fields (SAR)

**Standards:**

Emission:	EN 61000-6-3/A1:2011	Electromagnetic Compability Generic standards – Emission
Immunity:	EN 61000-6-2:2005	Electromagnetic Compability Generic standards – Immunity
Restricted substances (RoHS):	EN 50581:2012	Technical documentation
Radio:	ETSI EN 300 328 v2.1.1 ETSI EN 301 893 v1.8.1	Harmonized EN covering essential requirements of the R&TTE Directive
SAR:	EN 62209-2 EN 50566:2013/AC:2014 1999/519/EC	Human exposure Wireless Compliance (30 MHz – 6 GHz) Limitation (0 Hz to 300 GHz)
Safety (Power supply):	EN 60950	Information technology equipment

**FLIR Systems AB**  
Quality Assurance

Lea Dabiri  
Quality Manager

## Safety Data Sheet

SDS No.: 2019081401

Updated Date: 2019/Aug

### 1. Product and Company Identification

Important Note: As a solid, manufactured article, exposure to hazardous ingredients is not expected with normal use. This battery is an article pursuant to 29 CFR 1910.1200 and, as such, is not subject to the OSHA Hazard Communication Standard requirement. The information contained in this Safety Data Sheet contains valuable information critical to the safe handling and proper use of the product. This SDS should be retained and available for employees and other users of this product.

Commercial product name

365-8107(T300109)

Use of the substance/preparation

Lithium-Ion battery (INR18650-29E)

Manufacturer

Celltech (Zhongshan) Ltd.

Address

4th Floor, Building 3 / No. 6 Jiusha Road / Torch Development District / Zhongshan / China

Company/undertaking identification

Emergency Contact (CHEMTREC)

+86-760-87365930

Further Information

Battery-System: Lithium-Ion (Li-ion)

Nominal Voltage: 3.65V

Rated Capacity: 2.75Ah

Wh rating: 10.0375Wh

Remark:

The information and recommendations set forth are made in good faith and believed to be accurate as of the date of preparation. Celltech (Zhongshan) Ltd. makes no warranty, expressed or implied, with respect to this information and disclaims all liabilities from reliance on it.

### 2. Hazards Identification

Route(s) of Entry

There is no hazard when the measures for handling and storage are followed.

Signs and Symptoms of Exposure



In case of cell damage, possible release of dangerous substances and a flammable gas mixture.

OSHA Hazard Communication: This material is not considered hazardous by the OSHA Hazard Communication Standard 29CFR 1910.1200.

Carcinogenicity (NTP): Not listed  
 Carcinogenicity (IARC): Not listed  
 Carcinogenicity (OSHA): Not listed

Special hazards for human health and environment

There is no hazard when the measures for handling and storage are followed.

In case of cell damage, possible release of dangerous substances and a flammable gas mixture.

Explication of special hazards for human health and environment

Not classified as dangerous according to directive 1999/45/EEC

There is no hazard when the measures for handling and storage are followed.

In case of cell damage, possible release of dangerous substances and a flammable gas mixture.

### **3. Composition/information on ingredients**

Hazardous components

	<b>Chemical Name</b>	<b>CAS No.</b>	<b>*Mass range in cell (g/g %)</b>
Electrolyte	Contains Electrolyte salt and solvents.		5-20
Electrolyte salt	Lithium hexafluorophosphate	21324-40-3	0.05-5
Electrolyte solvent	Includes one or more of the following; Ethylene Carbonate Propylene Carbonate Diethyl Carbonate	96-49-1 108-32-7 105-58-8	5-20
PVDF	Polyvinylidene fluoride	24937-79-9	<1
Copper	Cu	7440-50-8	3-15
Aluminium	Al	7429-90-5	2-10
Cathode	Lithium cobalt oxide	12190-79-3	20-50
Anode	Graphite	7782-42-5	10-30
Steel, Nickel, and inert components		Various	Balance

Further Information

For information purposes:

(\*) Main ingredients: Lithium hexafluorophosphate, organic carbonates

Because of the cell structure the dangerous ingredients will not be available if used properly. During charge process a lithium graphite intercalation phase is formed.

Mercury content: Hg < 0.1mg/kg

Cadmium content: Cd < 1mg/kg

Lead content: Pb < 10mg/kg

#### **4. First Aid Measures**

##### General information

The following first aid measures are required only in case of exposure to interior battery components after damage of the external battery casing.

Undamaged, closed cells do not represent a danger to the health.

##### After inhalation

Ensure of fresh air. Consult a physician.

##### After contact with skin

In case of contact with skin wash off immediately with plenty of water.

Consult a physician.

##### After contact with eyes

Rinse immediately with plenty of water, also under the eyelids, for at least 15 minutes. Seek medical treatment by eye specialist.

##### After ingestion

Drink plenty of water.

Call a physician immediately.

#### **5. Fire Fighting Measures**

##### Suitable extinguishing media

Cold water and dry powder in large amount are applicable.

Use metal fire extinction powder or dry sand if only few cells are involved.

##### Special hazards arising from the chemical

May form hydrofluoric acid if electrolyte comes into contact with water.

In case of fire, the formation of the following flue gases cannot be excluded: Hydrogen fluoride (HF), Carbon monoxide and carbon dioxide.

##### Protective equipment and precautions for firefighters

Wear self-contained breathing apparatus and protective suit. Additional information

If possible, remove cell(s) from fire fighting area. If heated above 125°C, cell(s) can explode/vent. Cell is not flammable but internal organic material will burn if the cell is incinerated.

#### **6. Accidental Release Measures**

##### Personal precautions

Use personal protective clothing.

Avoid contact with skin, eyes and clothing. Avoid breathing fume and gas.

##### Environmental precautions

Do not discharge into the drains/surface waters/groundwater. Methods for cleaning up/taking up

Take up mechanically and send for disposal.

#### **7. Handling and Storage**

Handling

Advice on safe handling

Avoid short circuiting the cell. Avoid mechanical damage of the cell. Do not open or disassemble. Advice on protection against fire and explosion

Keep away from open flames, hot surfaces and sources of ignition.

Storage

Requirements for storage rooms and vessels

Storage at room temperature (approx. 20°C) at humidity approx. 60% of the nominal capacity.

Keep in closed original container.

**8. Exposure controls/personal protection Exposure limit values Exposure limits**

Ingredient	Risk Codes	Safety Description	Hazard	Exposure Controls/Personal Protection
Lithium Cobalt oxide	R22;R43; R50/53	S24; S37; S60; S61	Xn(Harmful) (Dangerous for the environment)	0.1 mg/m3 (TWA)
Manganese (VI) oxide	R20/22	S25	Xn(Harmful)	Airborne Exposure Limits: - OSHA Permissible Exposure Limit (PEL): 5 mg/m3 Ceiling for manganese compounds as Mn - ACGIH Threshold Limit Value (TLV): 0.2 mg/m3 (TWA) for manganese, elemental and inorganic compounds as Mn
Nickel oxide	R43,R49 R53, R36/37/38	S45,S53,S61	T(Toxic)	Airborne Exposure Limits: For Nickel, Metal and Insoluble Compounds, as Ni: - OSHA Permissible Exposure Limits (PEL) - 1 mg/m3 (TWA). For Nickel, Elemental / Metal: - ACGIH Threshold Limit Value (TLV) - 1.5 mg/m3 (TWA), A5 - Not suspected as a human carcinogen. For Nickel, Insoluble Compounds, as Ni: - ACGIH Threshold Limit Value (TLV) - 0.2 mg/m3 (TWA), A1 - Confirmed human carcinogen
Carbon	R36/37 R20, R10	S22; S24/25	F (Highly Flammable) Xn (Harmful) Xi(Irritant)	Airborne Exposure Limits: - OSHA Permissible Exposure Limits (PELs): activated carbon (graphite, synthetic): Total particulate = 15 mg/m3
Aluminium foil	R17,R15 R36/38 R10,R67, R65,R62 R51/53, R48/20, R38,R11	S7/8,S43,S26,S62, S61, S36/37, S33, S29, S16, S9	F(Highly Flammable) Xn(Harmful) Xi(Irritant)	Airborne Exposure Limits: -OSHA Permissible Exposure Limit (PEL): 15 mg/m3 (TWA) total dust and 5 mg/m3(TWA) Repairable fraction for Aluminum metal as Al -ACGIH Threshold Limit Value (TLV): 10 mg/m3 (TWA) Aluminum metal dusts
Copper foil	R11 R36 R37 R38	S5, S26, S16, S61, S36/37	F(Highly Flammable) N(Dangerous for the environment) Xn(Harmful) Xi(Irritant)	Copper Dust and Mists, as Cu: - OSHA Permissible Exposure Limit (PEL) - 1 mg/m3 (TWA) - ACGIH Threshold Limit Value (TLV) - 1 mg/m3 (TWA) Copper Fume: - OSHA Permissible Exposure Limit (PEL) 0.1 mg/m3 (TWA) - ACGIH Threshold Limit Value (TLV) - 0.2 mg/m3 (TWA)
Polyvinylidene fluoride(PVdF)		S22;S24/25		

Full text of each relevant R phrase can be found in heading 16.

Additional advice on limit values

During normal charging and discharging there is no release of product.

Occupational exposure controls

No specific precautions necessary.

Protective and hygiene measures

When using do not eat, drink or smoke. Wash hands before breaks and after work.

Respiratory protection

No specific precautions necessary.

Hand protection

No specific precautions necessary.

Eye protection

No specific precautions necessary.

Skin protection

No specific precautions necessary.

## **9. Physical and Chemical Properties**

### Appearance

Form: Solid  
Color: Various  
Odor: Odourless

### Important health, safety and environmental information

Test method

PH Value:	n.a.
Flash point:	n.a.
Lower explosion limits:	n.a.
Vapour pressure:	n.a.
Density:	n.a.
Water solubility:	Insoluble
Ignition temperature:	n.a.

## **10. Stability and Reactivity USA, EU**

Stability

Stable

Conditions to avoid

Keep away from open flames, hot surfaces and sources of ignition. Do not puncture, crush or incinerate.

Materials to avoid

No materials to be especially mentioned.

Hazardous decomposition products

In case of open cells, there is the possibility of hydrofluoric acid and carbon monoxide release.

Possibility of Hazardous Reactions

Will not occur

Additional information

No decomposition if stored and applied as directed.

### 11. Toxicological Information

Empirical data on effects on humans

If appropriately handled and if in accordance with the general hygienic rules, no damages to health have become known.

### 12. Ecological Information

Further information

Ecological injuries are not known or expected under normal use. Do not flush into surface water or sanitary sewer system.

### 13. Disposal Considerations

Advice on disposal

For recycling consult manufacturer.

Contaminated packaging

Disposal in accordance with local regulations.

### 14. Transport Information

The rechargeable Lithium-Ion battery pack as stated in Appendix are made in compliance to the requirements stated in the latest edition of the IATA Dangerous Goods Regulations Packing Instruction 965 section IB such that they can be transported as dangerous goods. However, if those lithium-ion battery packs are pack with or contained in an equipment, then it is the responsibility of the shipper to ensure that the consignment are packed in compliance to the 60th edition of the IATA Dangerous Goods Regulations section II of Packing Instruction 966 or 967 in order for that consignment to be declared as Non Dangerous Goods.

With regard to transport, the following regulations are cited and considered:

- The International Civil Aviation Organization (ICAO) Technical Instructions (2019-2020 Edition),
- The International Air Transport Association (IATA) Dangerous Goods Regulations (60th Edition, 2019)
- The International Maritime Dangerous Goods (IMDG) Code (2016 Edition, IMDG 37-14 Edition, Special Provision 188),
- US Hazardous Materials Regulations 49 CFR (Code of Federal Regulations)  
Sections 173.185 Lithium batteries and cells,
- The UN Recommendations on the Transport of Dangerous Goods, Manual of Tests and Criteria  
38.3 Lithium batteries, 6<sup>th</sup> revised edition
- UN No. 3480

Our products are properly classified, described, packaged, marked, and labeled, and are in proper condition for transportation according to all the applicable international and national governmental regulations, not limited to the above mentioned. We further certify that the enclosed products have been tested and fulfilled the requirements and conditions in accordance with UN Recommendations (T1 - T8) on the Transport of Dangerous Goods Model Regulations and the Manual of Testes and Criteria that can be treated as “**Dangerous Goods**”.

Test results of the UN Recommendation on the Transport of Dangerous Goods			
Manual of Test and Criteria (38.3 Lithium battery)		Test Results	Remark
No	Test item		
T1	Altitude Simulation	Pass	
T2	Thermal Test	Pass	
T3	Vibration	Pass	
T4	Shock	Pass	
T5	External Short Circuit	Pass	
T6	Impact	Pass	
T7	Overcharge	Pass	For pack only
T8	Forced Discharge	Pass	For cell only

The Batteries are protected so as to prevent short circuits including protection against contact with conductive materials Within the same packaging that could lead to a short circuit. The Batteries have been packed according to PI965, Section **IB** of the current 60th edition of the IATA Dangerous Goods Regulations 2019, therefore they can be carried as **Dangerous Goods**.

The outer packaging has been tested to protect the lithium batteries from damage caused by falling from a height of up to 1.2m. The Batteries have been tested to the safety standards of the UN Manual of Tests and Criteria, Part III, Subsection 38.3.

### 15. Regulatory Information U.S. Regulations

#### National Inventory TSCA

All of the components are listed on the TSCA inventory.

#### SARA

To the best of our knowledge this product contains no toxic chemicals subject to the supplier notification requirements of Section 313 of the Superfund Amendments and Reauthorization Act (SARA/EPCRA) and the requirements of 40 CFR Part 372.

### 16. Regulatory information EU

#### Labeling

Hazardous components which must be listed on the label

As an article the product does not need to be labeled in accordance with EC directives or respective national laws.

#### EU regulatory information

1999/13/EC (VOC): 0 %

### 17. Other Information

#### Hazardous Materials Information Label (HMIS)

Health: 0

Flammability: 0

Physical Hazard: 0

#### NFPA Hazard Ratings

Health: 0

Flammability: 0

Reactivity: 0

Unique Hazard:

#### Full text of R-phrases referred to under sections 2 and 3

R10	Flammable.
R20/22	Harmful by inhalation and if swallowed.
R22	Harmful if swallowed.
R34	Causes burns.
R40	Limited evidence of a carcinogenic effect.
R43	May cause sensitization by skin contact.
R48/23	Toxic: danger of serious damage to health by prolonged exposure through inhalation.
R49	May cause cancer by inhalation.
R50	Very toxic to aquatic organisms.
R53	May cause long-term adverse effects in the aquatic environment.

#### Further Information

Data of sections 4 to 8, as well as 10 to 12, do not necessarily refer to the use and the regular handling of the product (in this sense consult package leaflet and expert information), but to release of major amounts in case of accidents and irregularities. The information describes exclusively the safety requirements for the product

(s) And is based on the present level of our knowledge. This data does not constitute a guarantee for the characteristics of the product(s) as defined by the legal warranty regulations. "(n.a. = not applicable; n.d. = not determined)"

The data for the hazardous ingredients were taken respectively from the last version of the sub-contractor's safety data sheet.

1. Test report holder: Celltech Abatel AB  
Kista Science Tower, 17<sup>th</sup> Floor, Färögatan 33  
SE-164 51 Kista (Stockholm), Sweden  
Tel: +46 (0) 8 445 78 70  
order@celltech.se  
www.celltech.se
2. Manufacturer: Celltech (Zhongshan) Ltd  
4<sup>th</sup> Floor, Building 3, No. 6 Jiusha Road  
Torch Development District  
528437 Zhongshan, China (PRC)  
Tel: +86 760 8610 6022  
sales@celltechchina.com  
www.celltechchina.com
3. UN38.3 test lab: South China National Center of Metrology,  
Guangdong Institute of Metrology  
No. 30, Songbaidong Street, Guangyuan Road  
510405 Guangzhou, China (PRC)  
Tel: +86 208 6594 172  
scm@scm.com.cn  
www.scm.com.cn
4. Test report number: DCW201900143
5. Date of test report: 28<sup>th</sup> December 2018
6. Description of battery: Li-Ion battery, part number 365-8107/T300109  
3.65V, 2.75Ah, 10.04Wh, 1S1P  
Black plastic case with gold plated terminals  
Cell: INR18650-29E (UN38.3 approved)
7. UN38.3 tests successfully passed:

T1 – Altitude simulation	38.3.4.1
T2 – Thermal test	38.3.4.2
T3 – Vibration	38.3.4.3
T4 – Shock	38.3.4.4
T5 – External short circuit	38.3.4.5
T6 – Impact	38.3.4.6
T7 – Overcharge	38.3.4.7
T8 – Forced discharge	38.3.4.8
8. Assembled battery testing requirements: Not applicable
9. Edition of UN manual of Test and Criteria: 6<sup>th</sup> Revised Edition
10. Name and title of signatory:  
  

---

  
Berth Svensson  
Battery projects manager